

Rotary limit switches

FCR – FGR series



Rotary control switches with 300mm rods from 3 up to 5 positions. Control switches with rotary gear from 12 up to 200 rpm with 4 or 6 micro switches.

Rotary limit switches

FCR series for control circuits

IP65 

GENERAL CHARACTERISTICS

- Self extinguishing thermoplastic housing
VD UL94
- IP65 protection rating according to IEC/EN 60529
- Ambient temperature: operating -25° $+55^{\circ}$ C
storage -30° $+70^{\circ}$ C
- Material class II, Pollution class 3
according to IEC/EN60947
- Slow break positive opening
double gap contacts 
- No.1 cable entry 22,5 \varnothing

ELECTRICAL CHARACTERISTICS

Comply with IEC/EN60947-3, UL508		
Certifications IMQ, CCC, GOST, UL		
Rated insulation voltage U_i	V	690
Rated impulse withstand voltage U_{imp}	kV	4
Rated thermal current I_{th}	A	16
Frequency	Hz	50/60
Rated operating current:		
AC21A - AC22A	690V A	16
AC23A	3-phase - 3-pole	230V A/kW
		400V A/kW
Rated short circuit withstand current [gG 20A- 690V fuses]	kA	5



DESCRIPTION	REFERENCE NO.	WIRING DIAGRAM No.
For single-speed motor control		
3-position with mechanical interlock	FCR001	1
3-position with mechanical interlock	FCR002	2
4-position rotary	FCR003	3
4-position rotary	FCR004	4
4-position rotary	FCR005	5
For two-speed motor control		
4-position with mechanical interlock	FCR006	6

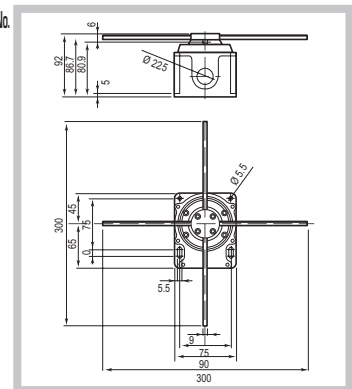

WIRING DIAGRAM 1

WITH MECHANICAL INTERLOCK

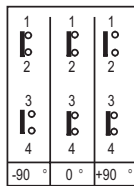

SINGLE-SPEED

WIRING DIAGRAM 2

WITH MECHANICAL INTERLOCK

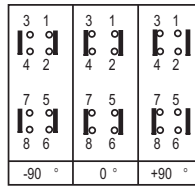

WIRING DIAGRAM 3

WITHOUT MECHANICAL INTERLOCK

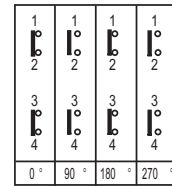

SINGLE-SPEED

WIRING DIAGRAM 4

WITHOUT MECHANICAL INTERLOCK

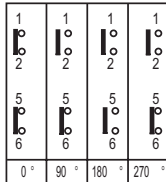

WIRING DIAGRAM 5

WITHOUT MECHANICAL INTERLOCK

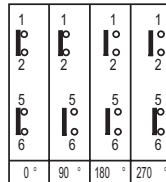

WIRING DIAGRAM 6

WITH MECHANICAL INTERLOCK

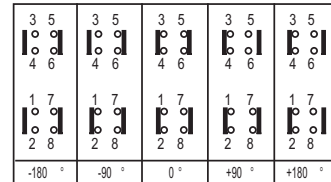

TWO-SPEED

Rotary gear limit switches

FGR series for control circuits

IP65 

GENERAL CHARACTERISTICS

This range is aimed at the control of rotating parts: crane rope drums, machinery, etc. They are supplied with a micro ,adjustable by a tool, to set the contacts to open and close independent from one another according to the different requirements. The FGR..B version is supplied with a coaxial shaft to use an encoder.

- Die cast main body with self extinguishing thermoplastic cover VO
- IP65 protection rating according to IEC/EN 60529
- Galvanised steel worm gear with ball bearings
- PA control cams with central stainless steel shaft mounted on ball bearings
- Cams and micrometric adjustment screws in PA
- Maximum number of operating contacts 6 (6 cams)
- No.2 cable entries with M20 cable glands
- Operating temperature -25° C + 70° C

ELECTRICAL CHARACTERISTICS

- Comply with IEC/EN 61058-1, UL 1054
- Certifications IMG, CCC, GOST, UL Recognized
- 1NC+1NO changeover switches (C form)
- Snap action contacts with positive opening NC contact 
- Self cleaning silver alloy contacts
- Rated insulation voltage Ui 250V
- Rated thermal current 8A
- Rated operating current:
resistive load Ie 8A-250V ac
inductive load Ie 3A-250V ac
- IEC/EN 61058-1 8(3)A-250V ac, UL 1054 8A-250Vac



STANDARD VERSION

CAM/MOTORSHAFT REV RATIO	REFERENCE NO.		WEIGHT gr	MIN. PACK QTY.
	With 4 micro switches	With 6 micro switches		
1/12	FGR2006	FGR20066	1.100	1
1/33	FGR2007	FGR20076	1.100	1
1/50	FGR2008	FGR20086	1.100	1
1/100	FGR2009	FGR20096	1.100	1
1/200	FGR2010	FGR20106	1.100	1

COAXIAL SHAFT VERSION

CAM/MOTORSHAFT REV RATIO	REFERENCE NO.		WEIGHT gr	MIN. PACK QTY.
	With 4 micro switches	With 6 micro switches		
1/12	FGR2006B	FGR2006B6	1.200	1
1/33	FGR2007B	FGR2007B6	1.200	1
1/50	FGR2008B	FGR2008B6	1.200	1
1/100	FGR2009B	FGR2009B6	1.200	1
1/200	FGR2010B	FGR2010B6	1.200	1

Rotary gear limit switches

FGR series for control circuits

IP65 

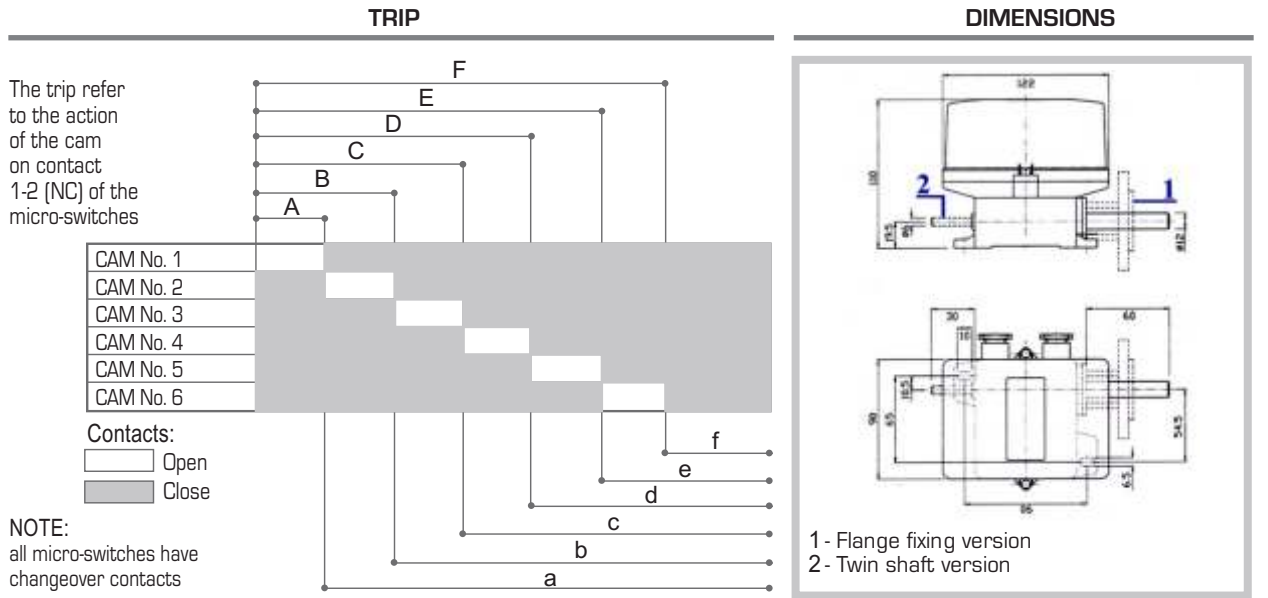

REVOLUTIONS REFERRED TO THE CAMS' ACTIVATION

RPM	A	a	B	b	C	c	D	d	E	e	F	f
12 revs	1,25	10,75	2,5	9,5	3,75	8,25	5	7	6,25	5,75	7,5	4,5
33 revs	3,5	29,5	7	26	10,5	22,5	14	19	17,5	15,5	21	13
50 revs	5	45	10	40	15	35	20	30	25	25	30	20
100 revs	10	90	20	80	30	70	40	60	50	50	60	40
200 revs	20	180	40	160	60	140	80	120	100	100	120	80

ACCESSORIES

The FLG flange in PA66, the Oldham coupling in PC reinforced with GF can be used on the main shaft.

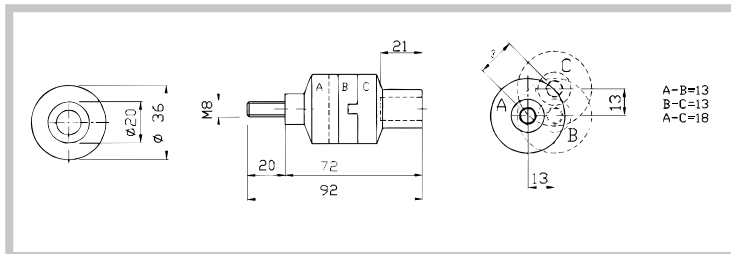
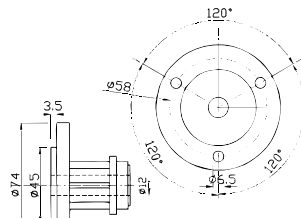



programmable
control systems



safety
remote controls



rotary
limit
switches



cabled
controls



general
purpose
radio
controls



foot
switches



PO BOX 5738
BRENDAL QLD 4500
AUSTRALIA

industryIQ

(t) +61 7 3889 9329
(f) +61 7 3889 9330
(e) support@industryiq.com.au
(w) www.industryiq.com.au